

NUSSBAUM
MEDICAL

CHIRURGIE PLASTIQUE

Mars 2024

- Chirurgie mammaire
- Chirurgie esthétique
- Canules de liposuccion



www.nussbaum-medical.fr

nussbaum.medical@gmail.com



ROND DE SEIN DU DR MOLE
double cranté
ø 38 / 42 mm
38-20100

ROND DE SEIN
double tranchant
ø 38 / 42 mm
38-20150



ROND DE SEIN DE FREEMAN
simple face

ø 38 mm **38-20138**
ø 42 mm **38-20142**
ø 44 mm **38-20144**



ANNEAU DE MARQUAGE
Mc KISSOCK
13cm

ø 38 mm **38-20070**
ø 42 mm **38-20080**
ø 45 mm **38-20090**



TENSEUR MAMMAIRE
DU DR MOLE
avec chaînette
en inox allégé
38-20200



TENSEUR MAMMAIRE
DU DR MOLE
avec crémaillère
en inox allégé
38-20220



TENSEUR MAMMAIRE
28 cm
en inox
38-20300

SÉPARATEUR DE YANCOSKIE

18 cm - DROIT
écartement : 150 mm
38-50918

SÉPARATEUR DE YANCOSKIE

18 cm - ARRONDI DEMI-CERCLE
écartement : 150 mm
38-50920

**SÉPARATEUR
MAMMAIRE**

22 cm **38-50722**
29,5 cm **38-50729**

**SÉPARATEUR
MAMMAIRE**

22 cm **38-50822**
29,5 cm **38-50829**

**DISSECTEUR
MAMMAIRE DE
MacCOLLUM-DINGMAN**

41 cm
38-50501

31,5 cm
38-50502

**DISSECTEUR
DE REYNOLDS**

40 cm
38-50605

**DÉCOLLEUR
SPATULÉ
DE TEBBETTS**

33 cm
38-49902

**DÉCOLLEUR
D'AGRIS-DINGMAN**
la paire : droite et gauche

36 cm
38-49800



CHIRURGIE MAMMAIRE / DISSECTEURS



DISSECTEUR MAMMAIRE
27 cm

125 x 30 mm
38-49625

140 x 30 mm
38-49630

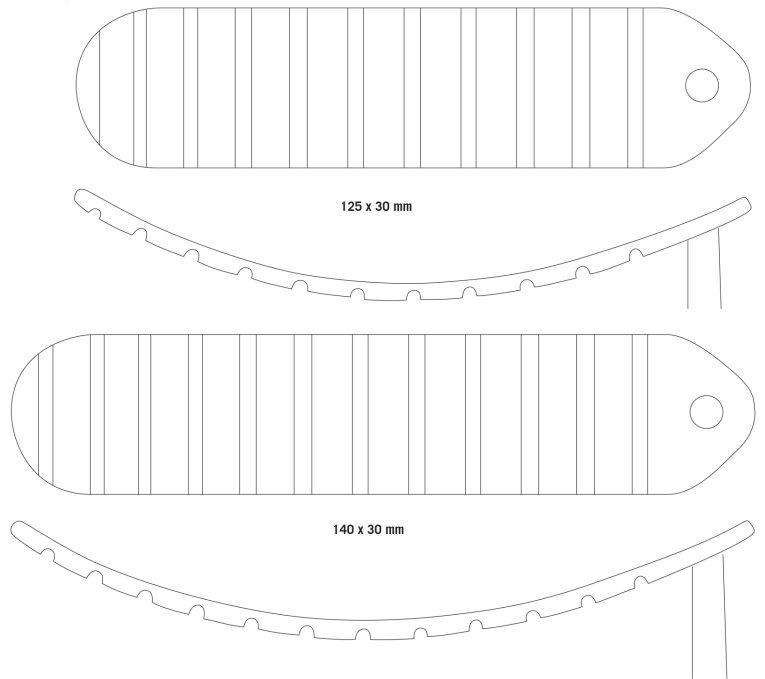

34 cm
38-49534



37 cm
38-49537

DISSECTEUR MAMMAIRE BAÏONNETTE

SPATULE MALLÉABLE
31 cm
29-39231



25 mm, 1"

15 cm, 6"

ÉCARTEUR PECTORAL DOUBLE
31 cm
29-39901

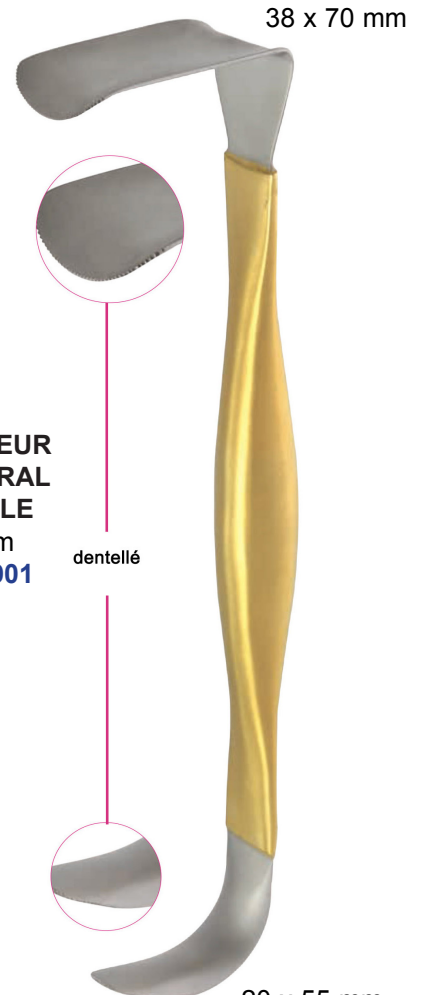

38 x 70 mm

dentellé

20 x 55 mm



SPATULE
CRANTÉE
MOUSSE



SPATULE
MOUSSE

ÉCARTEUR DE TEBBETTS

avec lumière froide et aspiration		
	Tailles	Références
	80 x 16 mm	29-39601
*	100 x 25 mm	29-39602
	120 x 25 mm	29-39603
	120 x 30 mm	29-39604
*	150 x 25 mm	29-39605
	150 x 30 mm	29-39606

ÉCARTEUR FERREIRA 19 cm

avec lumière froide et aspiration		
	Tailles	Références
	80 x 16 mm	29-39701
*	100 x 25 mm	29-39702
	120 x 25 mm	29-39703
	120 x 30 mm	29-39704
*	150 x 25 mm	29-39705
	150 x 30 mm	29-39706

ÉCARTEUR 4 GRIFFES POINTUES
PEIGNE À LIFTING DE FREEMAN

18 cm pointu

largeur 22 mm
29-39822largeur 38 mm
29-39838

(*) Disponible sans lumière froide : nous consulter



ÉCARTEUR
UNIVERSEL
POUR LIFTING
avec lumière froide
longueur 110 mm
largeur 20 mm
29-39200

idem avec lumière
froide et **aspiration**
longueur 130 mm
largeur 20 mm
29-39300



ÉCARTEUR
FREEMAN
MOUSSE
POUR LIFTING
20 cm
largeur 12 mm
38-49912



ÉCARTEUR
FREEMAN
MOUSSE
POUR LIFTING
20 cm
avec lumière froide
largeur 12 mm
38-49927



Fig. 1
20 cm

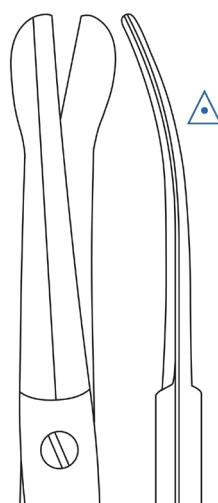

Fig. 2
20 cm



Fig. 3
15 cm

bords extérieurs semi-tranchants

La forme spéciale de l'embout des lames permet une séparation optimale et non-traumatisante des tissus.

CISEAUX DE SOLZ

SuperCut		
Fig.	Tailles	COURBES
Fig. 1	20 cm	204.79.20
Fig. 2	20 cm	214.79.20
Fig. 3	15 cm	214.79.15

CISEAUX POUR TUNNELISATION



CISEAUX DE FANOUS

SuperCut		
Tailles	DROITS	COURBES
16,5 cm	204.68.16	204.69.16
20,5 cm	204.68.20	204.69.20

CISEAUX DE
METZENBAUM

SuperCut	
Taille	COURBES
14 cm	204.32.14

CISEAUX DE
METZENBAUM-SLIM

SuperCut	
Taille	COURBES
14 cm	204.34.14

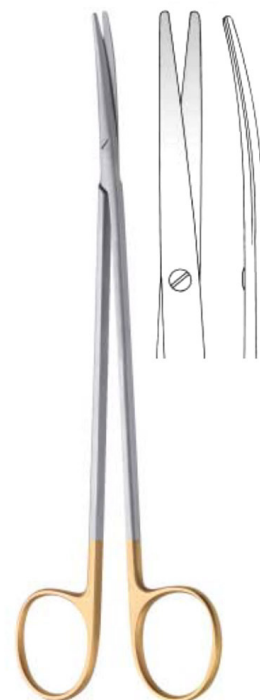
CISEAUX DE
TOENNIS-ADSON

TC (tungstène)	
Taille	COURBES
18 cm	204.63.18

CISEAUX POUR MAMMOPLASTIE - FACELIFT - ABDOMINOPLASTIE

CISEAUX DE
GORNEY
POINTES PLATES

SuperCut	
Taille	COURBES
23 cm	204.73.23

CISEAUX DE
GORNEY-FREEMAN
POINTES PLATES

SuperCut	
Taille	COURBES
23 cm	204.75.23

CISEAUX À IRIDECTOMIE



	Inox	
Taille	DROITS	COURBES
11,5 cm	11-630-11-07	11-631-11-07



	TC (tungstène)	
Taille	DROITS	COURBES
	11-982-11-07	11-983-11-07



	SuperCut	
Taille	DROITS	COURBES
	11-672-11-07	11-673-11-07

CISEAUX DE SHEA

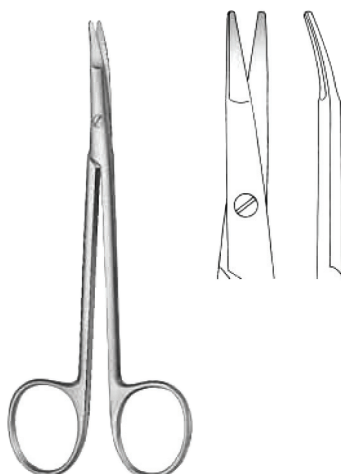

	Inox
Taille	COURBES
12 cm	11-357-12-07

CISEAUX DE JAMESON

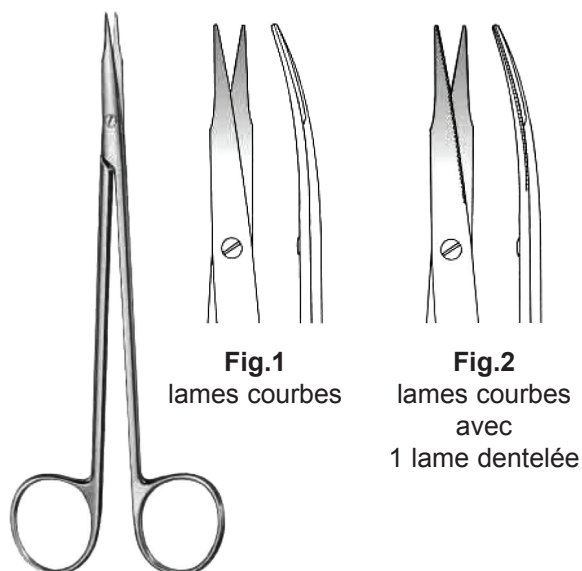

	Inox	
Taille	Fig. 1	Fig. 2
15,5 cm	11-248-11-07	11-249-11-07

CISEAUX DE BABY-METZENBAUM



	Inox	
Taille	DROITS	COURBES
11,5 cm	11-248-11-07	11-249-11-07

	TC (tungstène)	
Taille	DROITS	COURBES
11,5 cm	11-936-11-07	11-937-11-07

	SuperCut	
Taille	DROITS	COURBES
11,5 cm	11-658-11-07	11-659-11-07

CISEAUX DE RAGNELL

CISEAUX DE KILNER

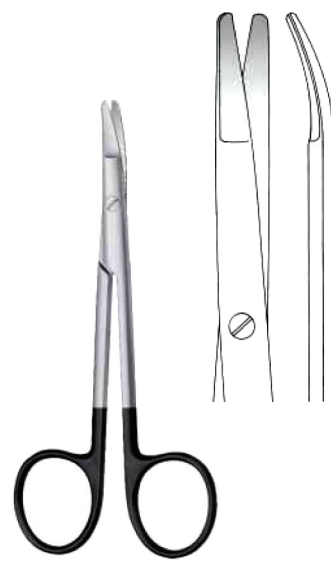

	TC (tungstène)	
Taille	COURBES	
12,5 cm	11-991-12-07	

	Inox	
Tailles	12 cm	15 cm
COURBES	11-359-12-07	11-359-15-07

	SuperCut	
Tailles	12 cm	15 cm
COURBES	11-669-12-07	11-669-15-07

CISEAUX DE STEVENS

lames droites



lames courbes



Inox		
POINTUS		
Taille	DROITS	COURBES
11 cm	11-680-11-07	11-681-11-07

SuperCut		
POINTUS		
Taille	DROITS	COURBES
11 cm	11-674-10-07	11-675-10-07



lames droites



lames courbes



Inox		
MOUSSES		
Taille	DROITS	COURBES
11 cm	11-682-11-07	11-683-11-07

SuperCut		
MOUSSES		
Taille	DROITS	COURBES
11 cm	11-676-10-07	11-677-10-07

CISEAUX DE KAYE

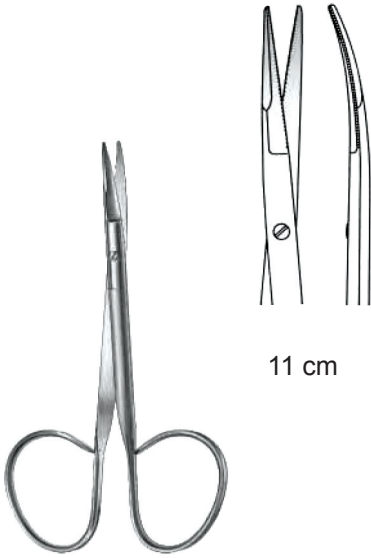

11 cm

lames courbes
avec
2 lames dentées

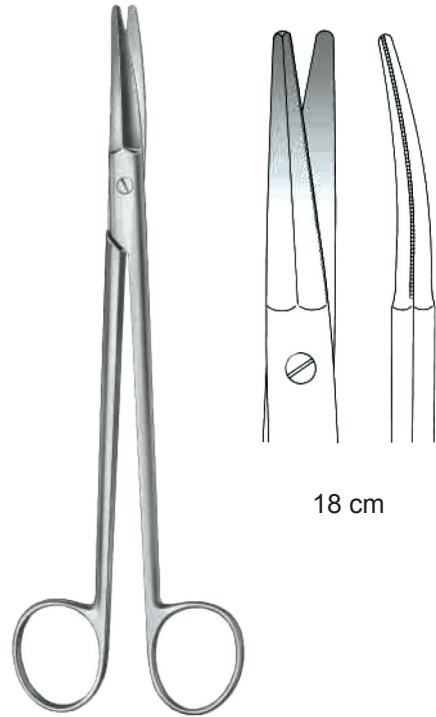

18 cm

	Inox
Taille	COURBES
11 cm	11-809-11-07

	Inox
Taille	COURBES
18 cm	11-305-00-07

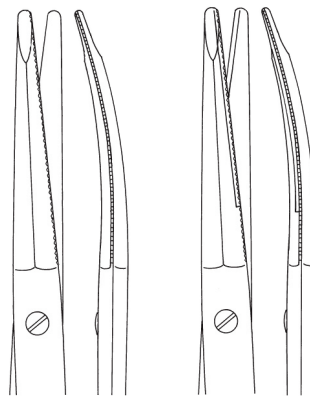

15 cm

18 cm

lames courbes
avec
1 lame dentée

	TC (tungstène)	
Tailles	15 cm	18 cm
COURBES	28-503-15-07	28-503-18-07

CISEAUX DE GORNEY

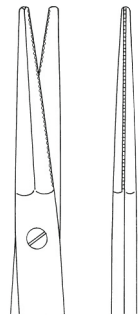

12,5 cm

2 lames dentées

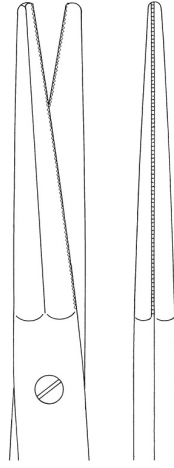

17 cm

2 lames dentées

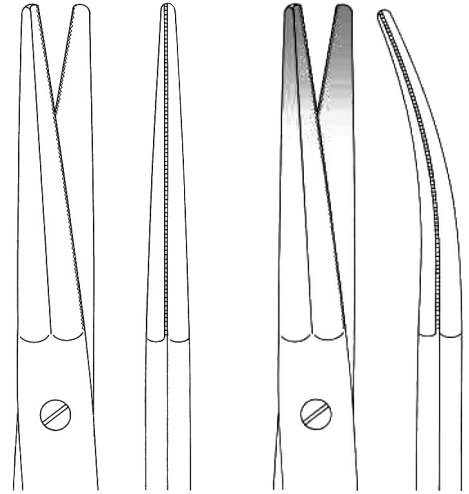

19,5 cm

2 lames dentées

	Inox	
Tailles	12,5 cm	17 cm
DROITS	11-306-12-07	11-308-17-07

	Inox	
Taille	DROITS	COURBES
19,5 cm	11-306-19-07	11-307-19-07

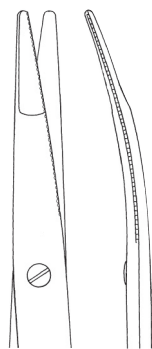
avec anneaux
décalés

1 lame dentée

	TC (tungstène)
Taille	COURBES
17,5 cm	28-521-18-07

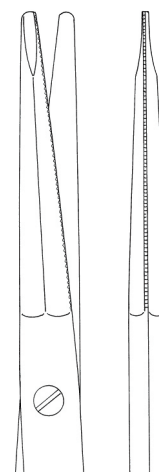

20 cm

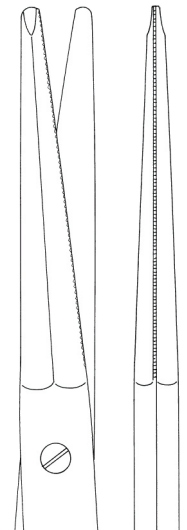
1 lame
dentée

23 cm

1 lame
dentée

	TC (tungstène)	
Tailles	20 cm	23 cm
DROITS	11-970-19-07	11-970-23-07

CISEAUX DE REES

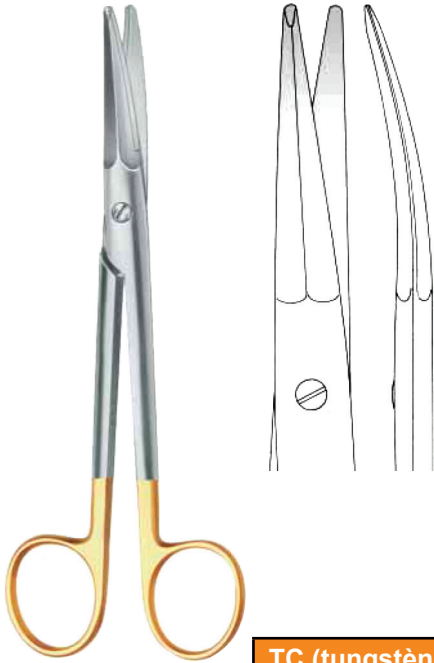

TC (tungstène)

Taille	17 cm
COURBES	11-973-17-07

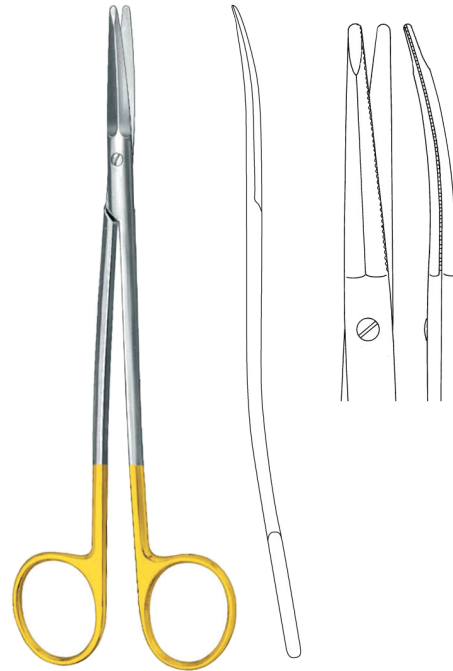
CISEAUX DE STELLA
EN S - CONTRECOUDÉS

TC (tungstène)

Taille	18 cm
COURBES	28-505-18-07

CISEAUX DE FREEMANN-KAYE

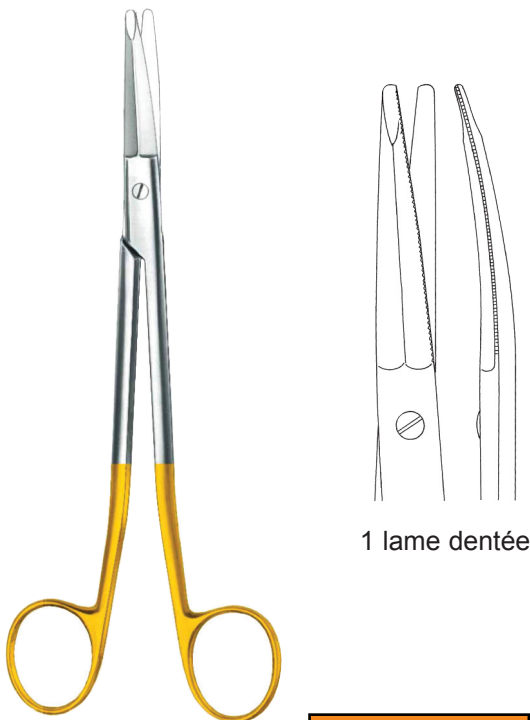

1 lame dentée

TC (tungstène)

Taille	18 cm
COURBES	28-525-18-07

CISEAUX DE FREEMANN



1 lame dentée

TC (tungstène)

Taille	23 cm
COURBES	28-529-23-07

**MANCHE À CANULE
VENDU SÉPARÉMENT**



**Connexion
Poignée**

**Connexion
Luer Lock**



CANULES TOLEDO

Forme de fourche et pointes arrondies

Surface de dissection tranchantes entre les pointes

1 trou central		
Tailles	Diam.	Connexion Poignée
5 cm	Ø 2 mm	38-95020
15 cm	Ø 3 mm	38-95430
25 cm	Ø 4 mm	38-95640
30 cm	Ø 5 mm	38-95850



CANULES MERCEDES

3 trous latéraux			
Tailles	Diam.	Connexion Poignée	Connexion Luer Lock
15 cm	Ø 2 mm	38-99020	-
15 cm	Ø 3 mm	38-99130	-
15 cm	Ø 4 mm	38-99240	-
20 cm	Ø 4 mm	-	38-89744
25 cm	Ø 3 mm	38-99330	-
25 cm	Ø 4 mm	38-99440	38-89754
25 cm	Ø 5 mm	38-99550	-
30 cm	Ø 4 mm	-	38-89764
30 cm	Ø 5 mm	38-99650	38-89765

**MANCHE À CANULE
VENDU SÉPARÉMENT**



**Connexion
Poignée**

**Connexion
Luer Lock**



CANULES MONOPORT
pour les contours fins du visage

1 trou central			
Tailles	Diam.	Connexion Poignée	Connexion Luer Lock
10 cm	Ø 2 mm	38-81320	38-82320
15 cm	Ø 3 mm	38-81630	38-82630



CANULES TRIPORT

3 trous centraux			
Tailles	Diam.	Connexion Poignée	Connexion Luer Lock
20 cm	Ø 3 mm	-	38-91830
20 cm	Ø 4 mm	-	38-91840
25 cm	Ø 3 mm	-	38-91930
30 cm	Ø 5 mm	38-91630	38-91940

**MANCHE À CANULE
VENDU SÉPARÉMENT**



CANULES FIGURE N°2

1 trou central 2 trous latéraux

Tailles	Diam.	Connexion Poignée
20 cm	∅ 3 mm	38-92030
30 cm	∅ 3 mm	38-92130
30 cm	∅ 4 mm	38-92230
30 cm	∅ 5 mm	38-92350
30 cm	∅ 6 mm	38-92460



CANULES FIGURE N°10

plusieurs trous en alternance

Tailles	Diam. canule	Diam. trou	Nbre de Trous	Connexion Poignée	Connexion Luer Lock
15 cm	∅ 2,0 mm	∅ 1,0 mm	18	38-85020	38-86020
15 cm	∅ 2,5 mm	∅ 1,2 mm	18	38-85125	38-86125
15 cm	∅ 3,0 mm	∅ 1,5 mm	18	38-85230	38-86230
20 cm	∅ 2,5 mm	∅ 1,2 mm	22	38-85325	38-86325
20 cm	∅ 3,0 mm	∅ 1,5 mm	22	38-85430	38-86430
20 cm	∅ 4,0 mm	∅ 2,0 mm	22	38-85540	38-86440
25 cm	∅ 2,5 mm	∅ 1,2 mm	26	38-85625	38-86625
30 cm	∅ 3,0 mm	∅ 1,5 mm	30	38-85730	38-86730
30 cm	∅ 4,0 mm	∅ 2,0 mm	30	38-85840	38-86840



Connexion
Poignée

Connexion
Luer Lock



CHIRURGIE ESTHÉTIQUE / MANCHES POUR LIPOSUCCION

CANULE VENDUE SÉPARÉMENT



Ø 13 mm

38-80113
13 cm, 5¼"



38-80213
13 cm, 5¼"



360°

Ø 13 mm

38-80313
13 cm, 5¼"



360°

38-80413
13 cm, 5¼"

LL



38-80514
14 cm, 5½"

LL



38-80614
14 cm, 5½"



38-80701
Ø 40 mm



38-80705
5 cm, 2"



**PORTE-AIGUILLE
OLSEN-HEGAR MINI**

TC (tungstène)	
Taille	Réf.
12 cm	27-42012



**PORTE-AIGUILLE
HALSEY**

TC (tungstène)	
Taille	Réf.
13,5 cm	27-40312



**PORTE-AIGUILLE
BAUMGARTNER**

TC (tungstène)	
Taille	Réf.
14 cm	27-40014



**PORTE-AIGUILLE
CRILE-WOOD**

TC (tungstène)	
Taille	Réf.
15 cm	27-40415



**PORTE-AIGUILLE
MINI-RYDER**

TC (tungstène)	
Taille	Réf.
13 cm	27-42013



**PORTE-AIGUILLE
OLSEN-HEGAR**

TC (tungstène)	
Tailles	Réf.
14,5 cm	20-672-14-07
17 cm	20-672-17-07
19 cm	20-672-18-07



MICRO PORTE-AIGUILLE DROIT
mors de 0,4 mm- Mors diamantés

Titane	
Taille	15 cm
AVEC BLOCAGE	20-016-15-09
SANS BLOCAGE	20-018-15-09



**PINCE D'AIACH
POUR FACELIFT**
pince presse-cartilage
16 cm
38-39046



**PINCE DE PITANGUY
À PRÉHENSION
DES LAMBEAUX**
16 cm
38-37014



**PINCE DE PITANGUY
AVEC GRIFFES**
16 cm
38-37016



**PINCE D'ASSUMPÇÃO
AVEC GRIFFES**
30 cm
38-38030

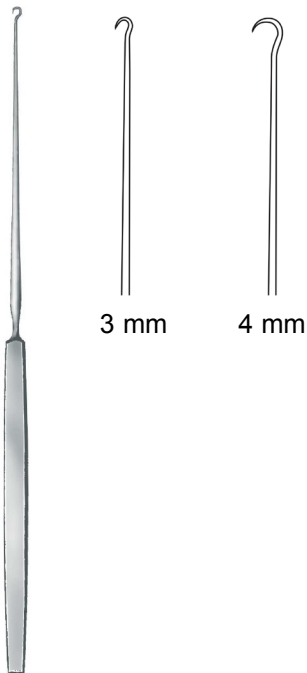

CROCHET GILLIES
18 cm
3 mm **29-40101**
4 mm **29-40102**



CROCHET BARSKY
15,5 cm
29-40250



CALIBREUR DE JAMESON
9,5 cm
15-11810

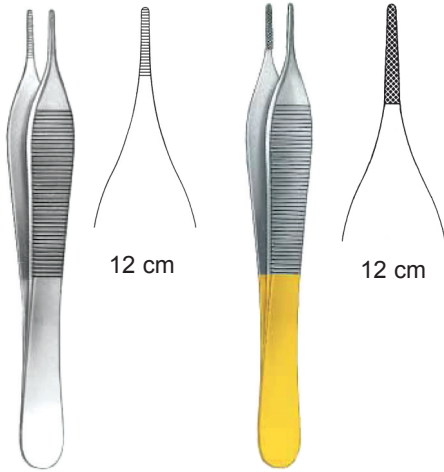

**MINI-CALIBREUR
À MESURE DE PROFONDEUR**
13 cm - ø 9 mm
15-11840

**PINCE ADSON**

Inox	TC (tungstène)
SANS GRIFFES	SANS GRIFFES
19-51012	19-51360

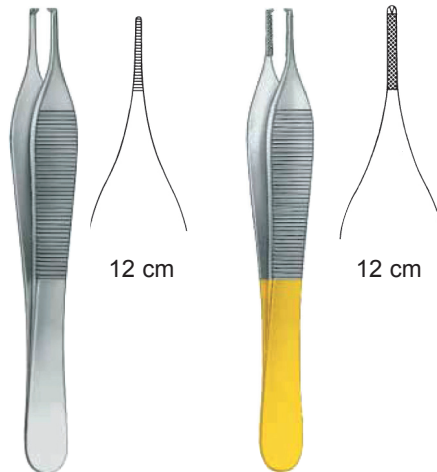
**PINCE ADSON**

Inox	TC (tungstène)
AVEC GRIFFES	AVEC GRIFFES
19-51212	19-51355

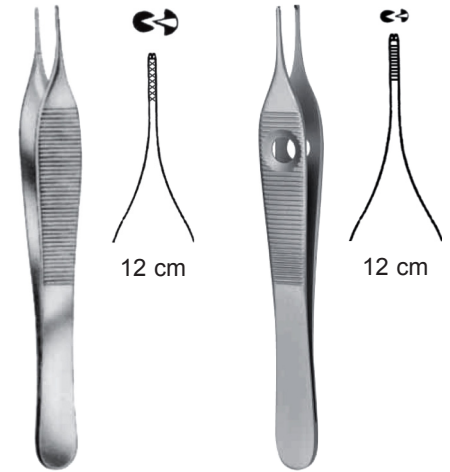
**PINCE ADSON**

Inox	
AVEC GRIFFES	AVEC GRIFFES
MORS STRIÉS CROISÉS	AVEC PLATEAU
19-51299	HB-360

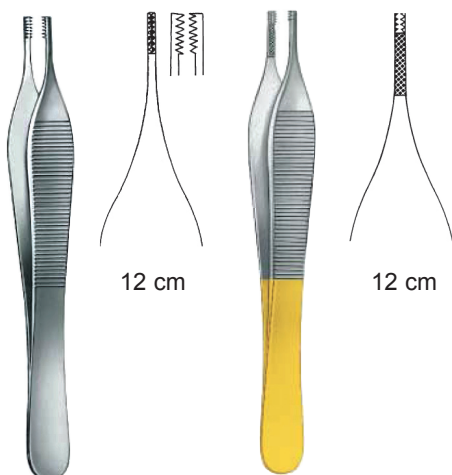
**PINCE ADSON-BROWN**

Inox	TC (tungstène)
AVEC GRIFFES	AVEC GRIFFES
19-51380	19-51385

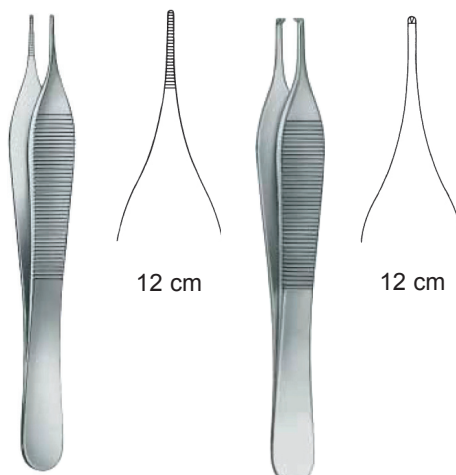
**PINCE MICRO-ADSON**

Inox	
SANS GRIFFES	AVEC GRIFFES
19-51112	19-51312

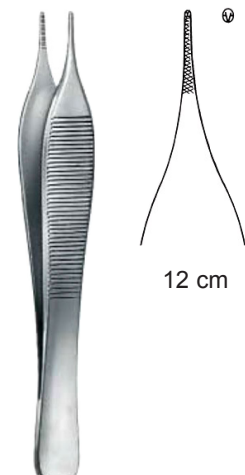
**PINCE MINI-ADSON**
MORS STRIÉS

Inox
AVEC GRIFFES
12-402-12-07

Visitez notre site vitrine en ligne

www.nussbaum-medical.fr



Implantée à Mulhouse depuis 1989, la société **NUSSBAUM MEDICAL** a choisi ses partenaires pour leur grand savoir-faire parmi les **meilleurs fabricants** et artisans de **France et d'Allemagne**, pour vous offrir une qualité de produits et d'instruments de chirurgie parfaite.

Nous sommes situés à égale distance du Bassin Nogentais, berceau de l'instrumentation chirurgicale française, et de Tuttlingen en Forêt Noire, ville dont l'activité tourne essentiellement autour des techniques médicales et dont la réputation est mondiale.

Nos articles et surtout nos instruments de chirurgie sont connus et utilisés par les cliniques et les hôpitaux à travers toute la France **depuis plus de 30 ans** pour leur plus grande satisfaction.



Produits en **conformité**
avec les **directives CE.**

NOUS CONTACTER

Par téléphone :
de **09h00 à 12h00**
de **14h00 à 17h30**
du lundi au jeudi
(**16h30** le vendredi)

Téléphone : **+ 33 (0)3 89 60 11 88**
Fax : **+ 33 (0)3 89 59 32 77**

Par email :
nussbaum.medical@gmail.com

Par courrier :
Société NUSSBAUM MEDICAL
31D, rue Victor Schœlcher
BP 3106
68062 MULHOUSE Cedex

NUSSBAUM
MEDICAL

CHIRURGIE MAMMAIRE ET ESTHÉTIQUE / ÉCARTEURS

SPATULE
CRANTÉE
MOUSSE



ÉCARTEUR DE TEBBETTS

avec lumière froide et aspiration

	Tailles	Références
	80 x 16 mm	29-39601
*	100 x 25 mm	29-39602
	120 x 25 mm	29-39603
	120 x 30 mm	29-39604
*	150 x 25 mm	29-39605
	150 x 30 mm	29-39606

(*) Disponible sans lumière froide : nous consulter

SPATULE
MOUSSE

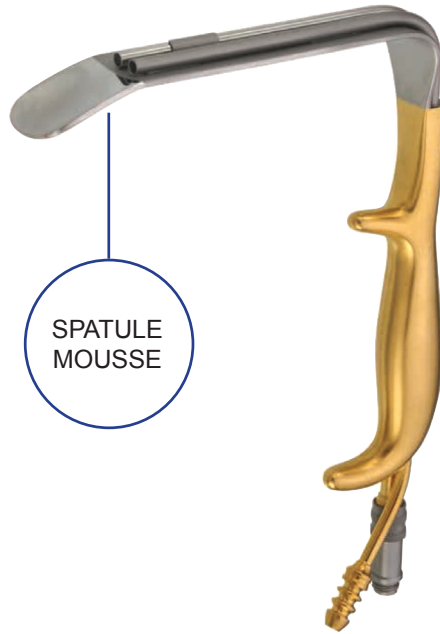

ÉCARTEUR FERREIRA 19 cm

avec lumière froide et aspiration

	Tailles	Références
	80 x 16 mm	29-39701
*	100 x 25 mm	29-39702
	120 x 25 mm	29-39703
	120 x 30 mm	29-39704
*	150 x 25 mm	29-39705
	150 x 30 mm	29-39706



**ÉCARTEUR 4 GRIFFES POINTUES
PEIGNE À LIFTING DE FREEMAN**

18 cm pointu

largeur 22 mm

29-39822

largeur 38 mm

29-39838



**ÉCARTEUR
UNIVERSEL
POUR LIFTING**

avec lumière froide
longueur 110 mm
largeur 20 mm

29-39200

idem avec lumière
froide et **aspiration**
longueur 130 mm
largeur 20 mm
29-39300

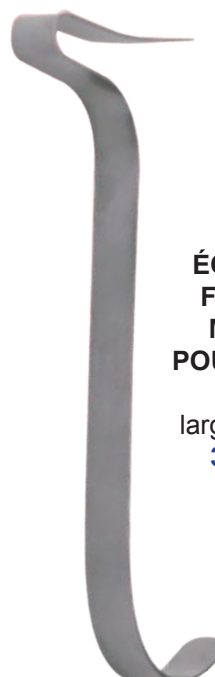

**ÉCARTEUR
FREEMAN
MOUSSE
POUR LIFTING**

20 cm
largeur 12 mm
38-49912



**ÉCARTEUR
FREEMAN
MOUSSE
POUR LIFTING**

20 cm
avec lumière froide
largeur 12 mm
38-49927