

**NUSSBAUM**  
**MEDICAL**

## CHIRURGIE PLASTIQUE

Novembre 2023

- Canules de liposuction
- Chirurgie mammaire
- Chirurgie esthétique

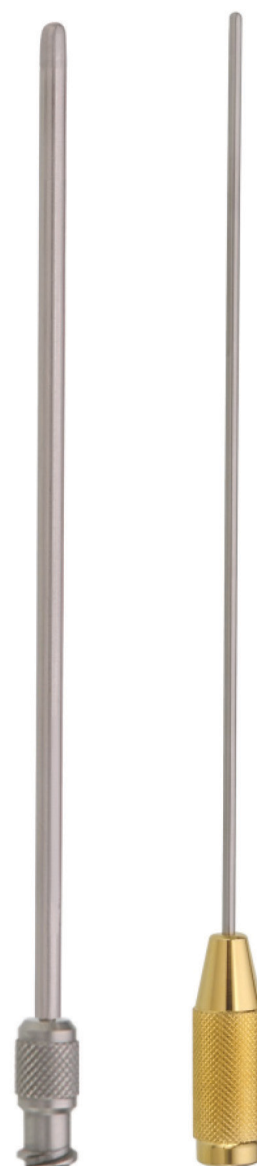

[www.nussbaum-medical.fr](http://www.nussbaum-medical.fr)

[nussbaum.medical@gmail.com](mailto:nussbaum.medical@gmail.com)

## CANULES POUR LIPOSUCCION

**MANCHE À CANULE  
VENDU SÉPARÉMENT**



**Connexion  
Poignée**

**Connexion  
Luer Lock**



### CANULES TOLEDO

Forme de fourche et pointes arrondies

Surface de dissection tranchantes entre les pointes

1 trou central		
Tailles	Diam.	Connexion Poignée
5 cm	Ø 2 mm	<b>38-95020</b>
15 cm	Ø 3 mm	<b>38-95430</b>
25 cm	Ø 4 mm	<b>38-95640</b>
30 cm	Ø 5 mm	<b>38-95850</b>



### CANULES MERCEDES

3 trous latéraux			
Tailles	Diam.	Connexion Poignée	Connexion Luer Lock
15 cm	Ø 2 mm	<b>38-99020</b>	-
15 cm	Ø 3 mm	<b>38-99130</b>	-
15 cm	Ø 4 mm	<b>38-99240</b>	-
20 cm	Ø 4 mm	-	<b>38-89744</b>
25 cm	Ø 3 mm	<b>38-99330</b>	-
25 cm	Ø 4 mm	<b>38-99440</b>	<b>38-89754</b>
25 cm	Ø 5 mm	<b>38-99550</b>	-
30 cm	Ø 4 mm	-	<b>38-89764</b>
30 cm	Ø 5 mm	<b>38-99650</b>	<b>38-89765</b>

## CANULES POUR LIPOSUCCION

**MANCHE À CANULE  
VENDU SÉPARÉMENT**



**Connexion  
Poignée**

**Connexion  
Luer Lock**



### CANULES MONOPORT

pour les contours fins du visage

1 trou central			
Tailles	Diam.	Connexion Poignée	Connexion Luer Lock
10 cm	Ø 2 mm	<b>38-81320</b>	<b>38-82320</b>
15 cm	Ø 3 mm	<b>38-81630</b>	<b>38-82630</b>



### CANULES TRIPORT

3 trous centraux			
Tailles	Diam.	Connexion Poignée	Connexion Luer Lock
20 cm	Ø 3 mm	-	<b>38-91830</b>
20 cm	Ø 4 mm	-	<b>38-91840</b>
25 cm	Ø 3 mm	-	<b>38-91930</b>
30 cm	Ø 5 mm	<b>38-91630</b>	<b>38-91940</b>



# MANCHES POUR LIPOSUCCION

**CANULE VENDUE  
SÉPARÉMENT**



Ø 13 mm

**38-80113**  
13 cm, 5¼"



**38-80213**  
13 cm, 5¼"



360°

Ø 13 mm

**38-80313**  
13 cm, 5¼"



360°

**38-80413**  
13 cm, 5¼"

LL



**38-80514**  
14 cm, 5½"

LL



**38-80614**  
14 cm, 5½"



**38-80701**  
Ø 40 mm



**38-80705**  
5 cm, 2"



**ROND DE SEIN DU DR MOLE**  
double cranté  
ø 38 / 42 mm  
**38-20100**

**ROND DE SEIN**  
double tranchant  
ø 38 / 42 mm  
**38-20150**



**ROND DE SEIN DE FREEMAN**  
simple face

ø 38 mm ..... **38-20138**  
ø 42 mm ..... **38-20142**  
ø 44 mm ..... **38-20144**



**ANNEAU DE MARQUAGE**  
Mc KISSOCK  
13cm

ø 38 mm .... **38-20070**  
ø 42 mm .... **38-20080**  
ø 45 mm .... **38-20090**



**TENSEUR MAMMAIRE**  
**DU DR MOLE**  
avec chaînette  
en inox allégé  
**38-20200**



**TENSEUR MAMMAIRE**  
**DU DR MOLE**  
avec crémaillère  
en inox allégé  
**38-20220**



**TENSEUR MAMMAIRE**  
28 cm  
en inox  
**38-20300**

## ÉCARTEURS



SPATULE  
CRANTÉE  
MOUSSE

**ÉCARTEUR DE TEBBETTS**  
avec lumière froide et aspiration

80 x 16 mm ..... **29-39601**  
100 x 25 mm ..... **29-39602**  
120 x 25 mm ..... **29-39603**  
120 x 30 mm ..... **29-39604**  
150 x 25 mm ..... **29-39605**  
150 x 30 mm ..... **29-39606**



SPATULE  
MOUSSE

**ÉCARTEUR FERREIRA**  
avec lumière froide  
19 cm

80 x 16 mm ..... **29-39701**  
100 x 25 mm ..... **29-39702**  
120 x 25 mm ..... **29-39703**  
120 x 30 mm ..... **29-39704**  
150 x 25 mm ..... **29-39705**  
150 x 30 mm ..... **29-39706**



**ÉCARTEUR 4 GRIFFES POINTUES**  
**PEIGNE À LIFTING DE FREEMAN**  
18 cm pointu

largeur 22 mm **29-39822**  
largeur 38 mm **29-39838**



**ÉCARTEUR  
UNIVERSEL  
POUR LIFTING**  
avec lumière froide  
longueur 110 mm  
largeur 20 mm  
**29-39200**

idem avec lumière  
froide et **aspiration**  
longueur 130 mm  
largeur 20 mm  
**29-39300**



**ÉCARTEUR  
FREEMAN  
MOUSSE  
POUR LIFTING**  
20 cm  
largeur 12 mm  
**38-49912**



**ÉCARTEUR  
FREEMAN  
MOUSSE  
POUR LIFTING**  
20 cm  
avec lumière froide  
largeur 12 mm  
**38-49927**

## DÉCOLLEURS



**SÉPARATEUR DE YANCOSKIE**

18 cm - DROIT  
écartement : 150 mm  
**38-50918**



**SÉPARATEUR DE YANCOSKIE**

18 cm - ARRONDI DEMI-CERCLE  
écartement : 150 mm  
**38-50920**



**SÉPARATEUR  
MAMMAIRE**

22 cm **38-50722**  
29,5 cm **38-50729**



**SÉPARATEUR  
MAMMAIRE**

22 cm **38-50822**  
29,5 cm **38-50829**



**DISSECTEUR  
MAMMAIRE DE  
MacCOLLUM-DINGMAN**

41 cm  
**38-50501**

31,5 cm  
**38-50502**



**DISSECTEUR  
DE REYNOLDS**

40 cm  
**38-50605**



**DÉCOLLEUR  
SPATULÉ  
DE TEBBETTS**

33 cm  
**38-49902**



**DÉCOLLEUR  
D'AGRIS-DINGMAN**  
la paire : droite et gauche

36 cm  
**38-49800**



# DISSECTEURS



**DISSECTEUR  
MAMMAIRE**  
27 cm

125 x 30 mm  
**38-49625**

140 x 30 mm  
**38-49630**

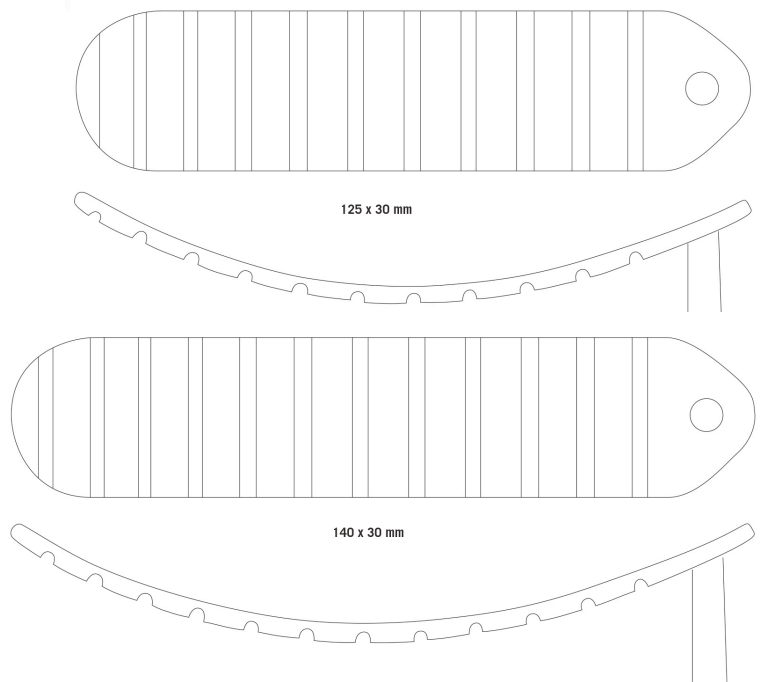

34 cm  
**38-49534**



37 cm  
**38-49537**

**DISSECTEUR MAMMAIRE  
BAÏONNETTE**

**SPATULE  
MALLÉABLE**  
31 cm  
**29-39231**



**ÉCARTEUR  
PECTORAL  
DOUBLE**  
31 cm  
**29-39901**

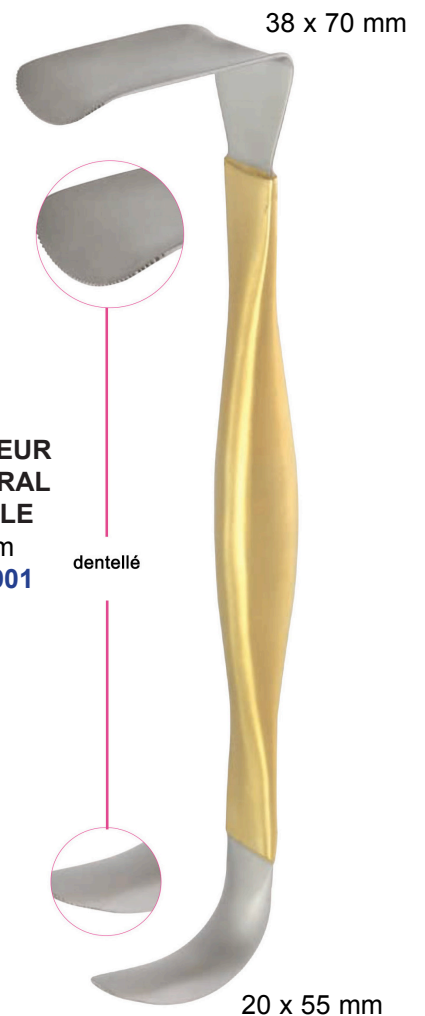



## PINCES ET CROCHETS



**PINCE D'AIACH  
POUR FACELIFT**  
pince presse-cartilage  
16 cm  
**38-39046**



**PINCE DE PITANGUY  
À PRÉHENSION  
DES LAMBEAUX**  
16 cm  
**38-37014**



**PINCE DE PITANGUY  
AVEC GRIFFES**  
16 cm  
**38-37016**



**PINCE D'ASSUMPÇÃO  
AVEC GRIFFES**  
30 cm  
**38-38030**

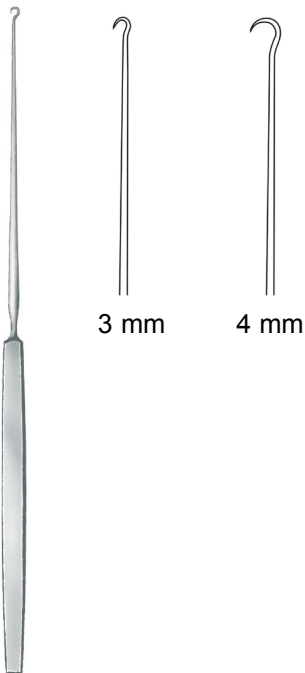

**CROCHET GILLIES**  
18 cm  
3 mm **29-40101**  
4 mm **29-40102**



**CROCHET BARSKY**  
15,5 cm  
**29-40250**



**CALIBREUR DE JAMESON**  
9,5 cm  
**15-11810**

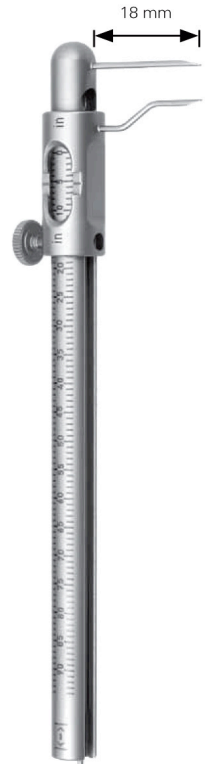

**MINI-CALIBREUR  
À MESURE DE PROFONDEUR**  
13 cm - ø 9 mm  
**15-11840**

## PINCETTES À DISSECTION

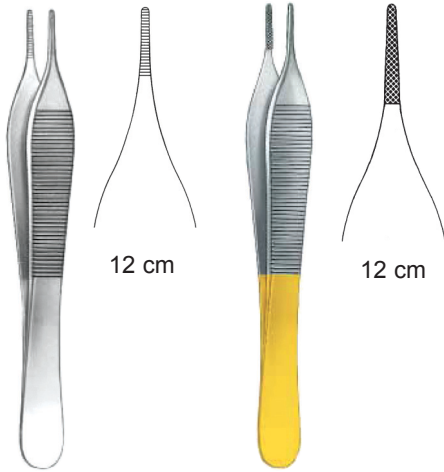

**PINCE ADSON**

Inox	TC (tungstène)
SANS GRIFFES	SANS GRIFFES
<b>19-51012</b>	<b>19-51360</b>

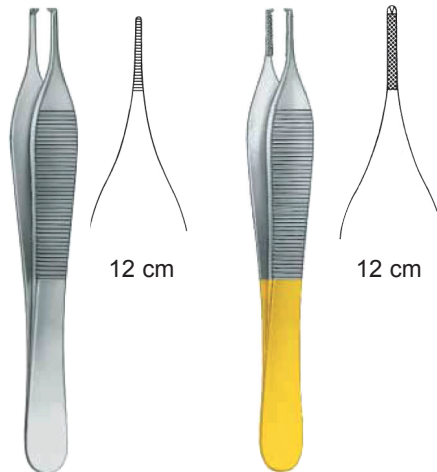

**PINCE ADSON**

Inox	TC (tungstène)
AVEC GRIFFES	AVEC GRIFFES
<b>19-51212</b>	<b>19-51355</b>

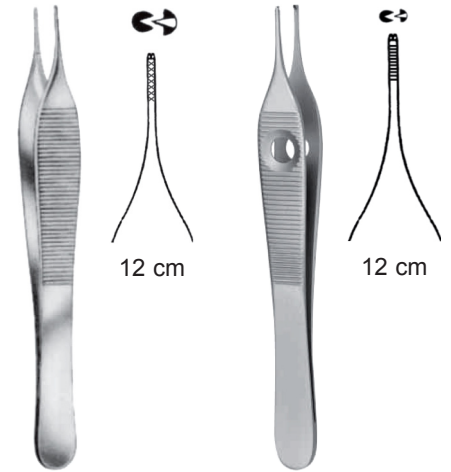

**PINCE ADSON**

Inox	
AVEC GRIFFES	AVEC GRIFFES
MORS STRIÉS CROISÉS	AVEC PLATEAU
<b>19-51299</b>	<b>HB-360</b>

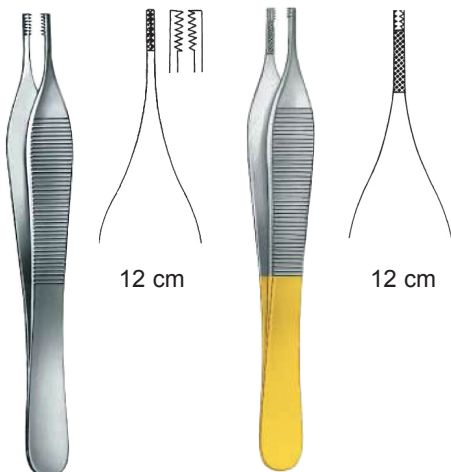

**PINCE ADSON-BROWN**

Inox	TC (tungstène)
AVEC GRIFFES	AVEC GRIFFES
<b>19-51380</b>	<b>19-51385</b>

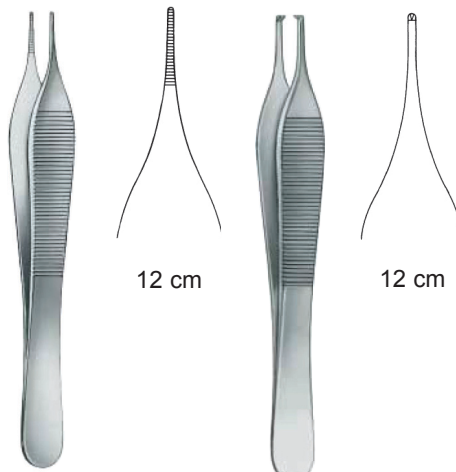

**PINCE MICRO-ADSON**

Inox	
SANS GRIFFES	AVEC GRIFFES
<b>19-51112</b>	<b>19-51312</b>



**PINCE MINI-ADSON**  
MORS STRIÉS

Inox
AVEC GRIFFES
<b>12-402-12-07</b>

## PORTE-AIGUILLES



**PORTE-AIGUILLE  
OLSEN-HEGAR MINI**

TC (tungstène)	
Taille	Réf.
12 cm	<b>27-42012</b>



**PORTE-AIGUILLE  
HALSEY**

TC (tungstène)	
Taille	Réf.
13,5 cm	<b>27-40312</b>



**PORTE-AIGUILLE  
BAUMGARTNER**

TC (tungstène)	
Taille	Réf.
14 cm	<b>27-40014</b>



**PORTE-AIGUILLE  
CRILE-WOOD**

TC (tungstène)	
Taille	Réf.
15 cm	<b>27-40415</b>



**PORTE-AIGUILLE  
MINI-RYDER**

TC (tungstène)	
Taille	Réf.
13 cm	<b>27-42013</b>



**PORTE-AIGUILLE  
OLSEN-HEGAR**

TC (tungstène)	
Tailles	Réf.
14,5 cm	<b>20-672-14-07</b>
17 cm	<b>20-672-17-07</b>
19 cm	<b>20-672-18-07</b>



**MICRO PORTE-AIGUILLE DROIT**  
mors de 0,4 mm- Mors diamantés

Titane	
Taille	15 cm
AVEC BLOCAGE	<b>20-016-15-09</b>
SANS BLOCAGE	<b>20-018-15-09</b>

## CISEAUX DÉLICATS

### CISEAUX À IRIDECTOMIE



	Inox	
Taille	DROITS	COURBES
11,5 cm	11-630-11-07	11-631-11-07

	TC (tungstène)	
Taille	DROITS	COURBES
	11-982-11-07	11-983-11-07

	SuperCut	
Taille	DROITS	COURBES
	11-672-11-07	11-673-11-07

### CISEAUX DE SHEA

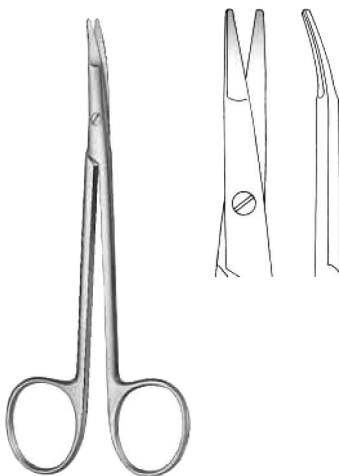

	Inox	
Taille	COURBES	
12 cm	11-357-12-07	

### CISEAUX DE JAMESON

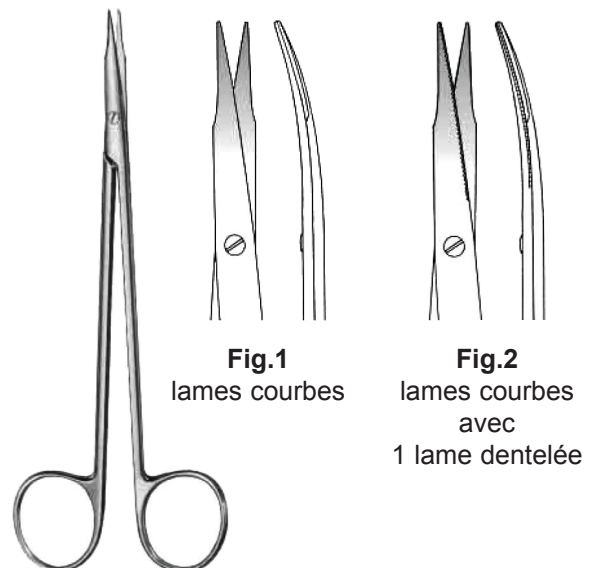

**Fig.1**  
lames courbes

**Fig.2**  
lames courbes  
avec  
1 lame dentelée

	Inox	
Taille	Fig. 1	Fig. 2
15,5 cm	11-248-11-07	11-249-11-07

## CISEAUX DÉLICATS

### CISEAUX DE BABY-METZENBAUM



	Inox	
Taille	DROITS	COURBES
11,5 cm	11-248-11-07	11-249-11-07

	TC (tungstène)	
Taille	DROITS	COURBES
11,5 cm	11-936-11-07	11-937-11-07

	SuperCut	
Taille	DROITS	COURBES
11,5 cm	11-658-11-07	11-659-11-07

### CISEAUX DE RAGNELL

### CISEAUX DE KILNER

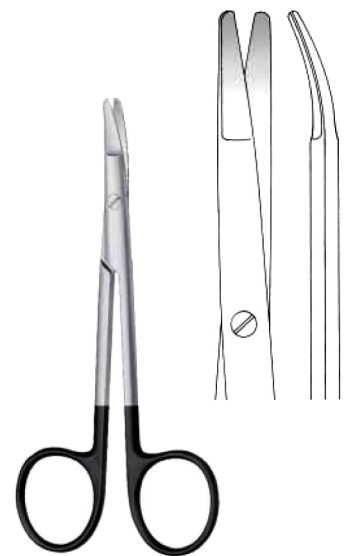

	TC (tungstène)	
Taille	COURBES	
12,5 cm	11-991-12-07	

	Inox	
Tailles	12 cm	15 cm
COURBES	11-359-12-07	11-359-15-07

	SuperCut	
Tailles	12 cm	15 cm
COURBES	11-669-12-07	11-669-15-07

**CISEAUX DÉLICATS**
**CISEAUX DE STEVENS**

lames droites



lames courbes



Inox		
POINTUS		
Taille	DROITS	COURBES
11 cm	<b>11-680-11-07</b>	<b>11-681-11-07</b>

SuperCut		
POINTUS		
Taille	DROITS	COURBES
11 cm	<b>11-674-10-07</b>	<b>11-675-10-07</b>



lames droites



lames courbes



Inox		
MOUSSES		
Taille	DROITS	COURBES
11 cm	<b>11-682-11-07</b>	<b>11-683-11-07</b>

SuperCut		
MOUSSES		
Taille	DROITS	COURBES
11 cm	<b>11-676-10-07</b>	<b>11-677-10-07</b>

## CISEAUX POUR FACE-LIFT

### CISEAUX DE KAYE

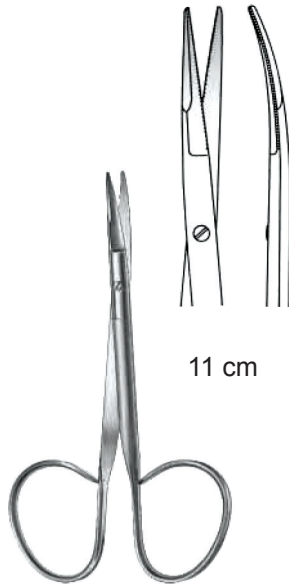

11 cm

lames courbes  
avec  
2 lames dentées

	Inox
Taille	COURBES
11 cm	<b>11-809-11-07</b>

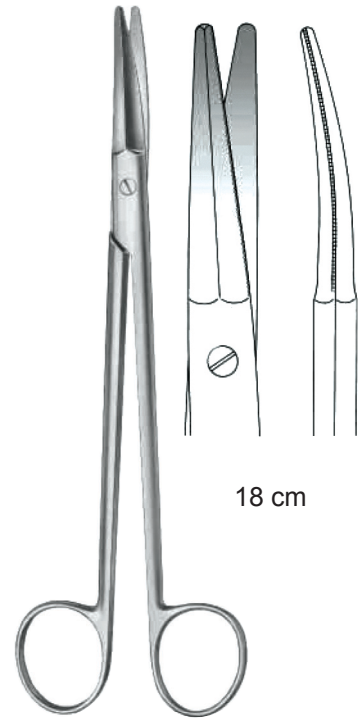

18 cm

	Inox
Taille	COURBES
18 cm	<b>11-305-00-07</b>

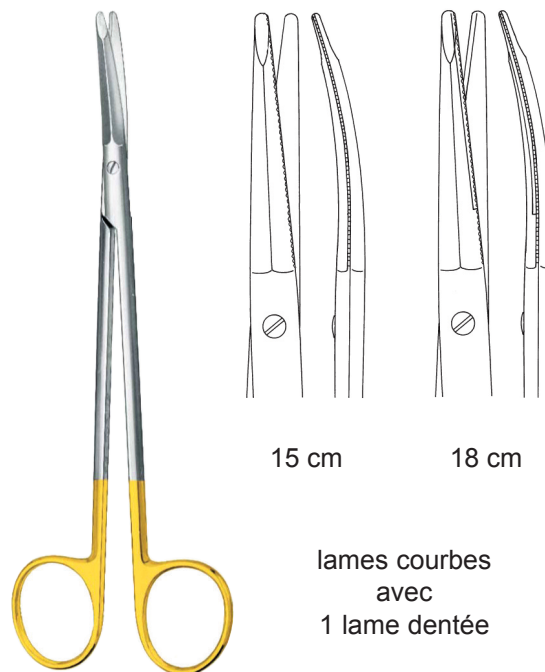

15 cm

18 cm

lames courbes  
avec  
1 lame dentée

	TC (tungstène)	
Tailles	15 cm	18 cm
COURBES	<b>28-503-15-07</b>	<b>28-503-18-07</b>

## CISEAUX POUR FACE-LIFT

### CISEAUX DE GORNEY

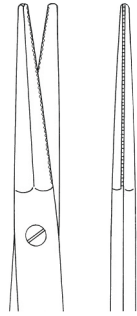

12,5 cm

2 lames dentées

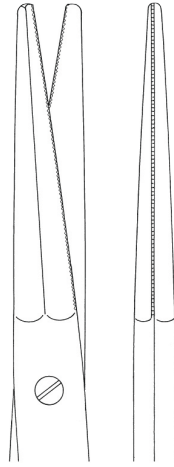

17 cm

2 lames dentées

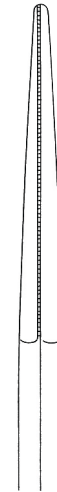
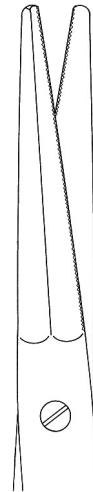

19,5 cm

2 lames dentées



	Inox	
Tailles	12,5 cm	17 cm
DROITS	<b>11-306-12-07</b>	<b>11-308-17-07</b>

	Inox	
Taille	DROITS	COURBES
19,5 cm	<b>11-306-19-07</b>	<b>11-307-19-07</b>

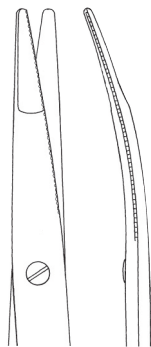

avec anneaux décalés

1 lame dentée

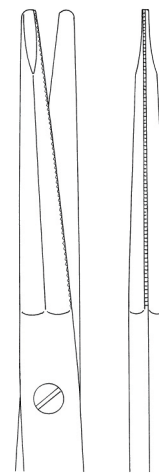

20 cm

1 lame dentée

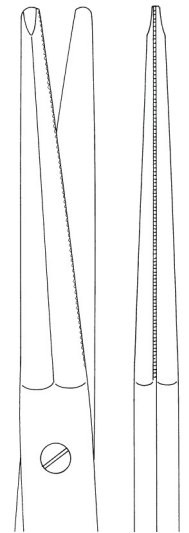

23 cm

1 lame dentée

	TC (tungstène)
Taille	COURBES
17,5 cm	<b>28-521-18-07</b>

	TC (tungstène)	
Tailles	20 cm	23 cm
DROITS	<b>11-970-19-07</b>	<b>11-970-23-07</b>



## CISEAUX POUR FACE-LIFT

### CISEAUX DE REES



	TC (tungstène)
Taille	17 cm
COURBES	<b>11-973-17-07</b>

### CISEAUX DE STELLA EN S - CONTRECOUDÉS

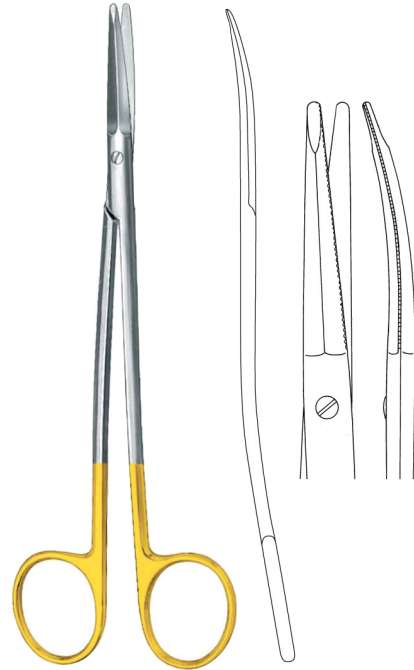

	TC (tungstène)
Taille	18 cm
COURBES	<b>28-505-18-07</b>

### CISEAUX DE FREEMANN-KAYE

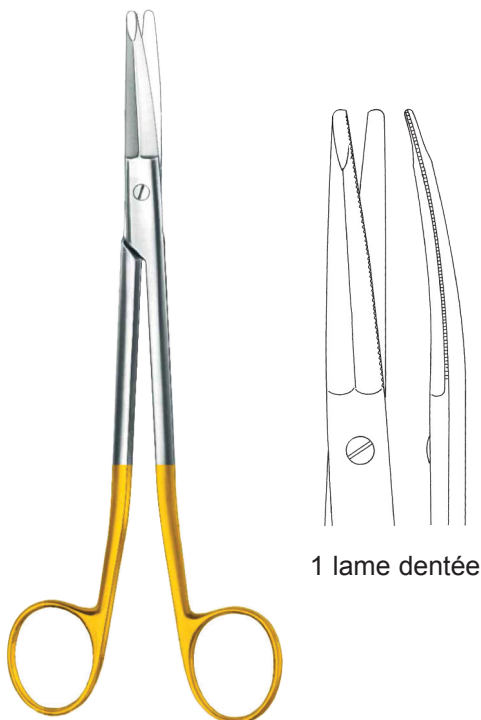

1 lame dentée

	TC (tungstène)
Taille	18 cm
COURBES	<b>28-525-18-07</b>

### CISEAUX DE FREEMANN

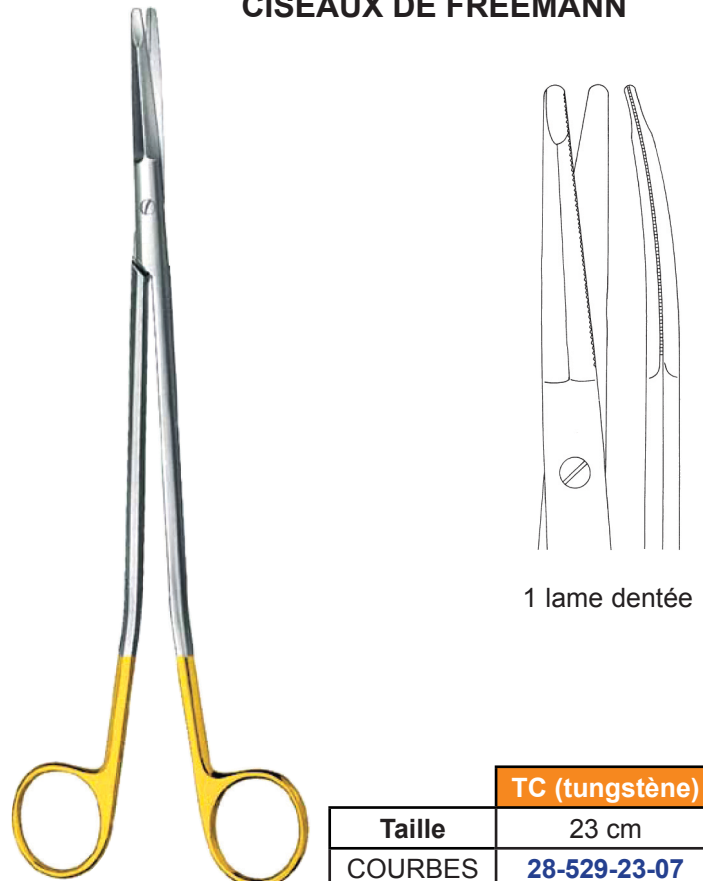

1 lame dentée

	TC (tungstène)
Taille	23 cm
COURBES	<b>28-529-23-07</b>

## CISEAUX

### CISEAUX POUR DISSECTION



**CISEAUX DE  
METZENBAUM**

SuperCut	
Taille	COURBES
14 cm	<b>204.32.14</b>



**CISEAUX DE  
METZENBAUM-SLIM**

SuperCut	
Taille	COURBES
14 cm	<b>204.34.14</b>

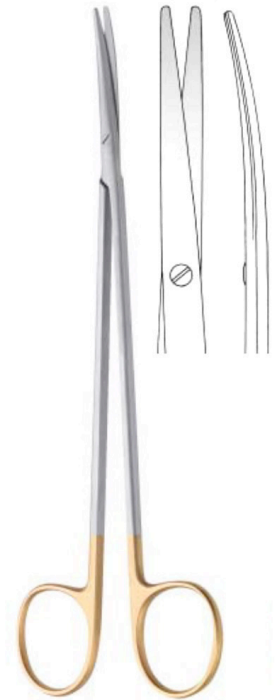

**CISEAUX DE  
TOENNIS-ADSON**

TC (tungstène)	
Taille	COURBES
18 cm	<b>204.63.18</b>

### CISEAUX POUR MAMMOPLASTIE - FACELIFT - ABDOMINOPLASTIE



**CISEAUX DE  
GORNEY  
POINTES PLATES**

SuperCut	
Taille	COURBES
23 cm	<b>204.73.23</b>



**CISEAUX DE  
GORNEY-FREEMAN  
POINTES PLATES**

SuperCut	
Taille	COURBES
23 cm	<b>204.75.23</b>

## CISEAUX

### CISEAUX POUR MAMMOPLASTIE



**Fig. 1**  
20 cm



**Fig. 2**  
20 cm



**Fig. 3**  
15 cm

bords extérieurs semi-tranchants

La forme spéciale de l'embout des lames permet une séparation optimale et non-traumatisante des tissus.

### CISEAUX DE SOLZ

SuperCut		
Fig.	Tailles	COURBES
<b>Fig. 1</b>	20 cm	<b>204.79.20</b>
<b>Fig. 2</b>	20 cm	<b>214.79.20</b>
<b>Fig. 3</b>	15 cm	<b>214.79.15</b>

### CISEAUX POUR TUNNELISATION



### CISEAUX DE FANOUS

SuperCut		
Tailles	DROITS	COURBES
16,5 cm	<b>204.68.16</b>	<b>204.69.16</b>
20,5 cm	<b>204.68.20</b>	<b>204.69.20</b>

# Visitez notre site vitrine en ligne

## [www.nussbaum-medical.fr](http://www.nussbaum-medical.fr)



Implantée à Mulhouse depuis 1989, la société **NUSSBAUM MEDICAL** a choisi ses partenaires pour leur grand savoir-faire parmi les **meilleurs fabricants** et artisans de **France et d'Allemagne**, pour vous offrir une qualité de produits et d'instruments de chirurgie parfaite.

Nous sommes situés à égale distance du Bassin Nogentais, berceau de l'instrumentation chirurgicale française, et de Tuttlingen en Forêt Noire, ville dont l'activité tourne essentiellement autour des techniques médicales et dont la réputation est mondiale.

**Nos articles et surtout nos instruments de chirurgie sont connus** et utilisés par les cliniques et les hôpitaux à travers toute la France **depuis plus de 30 ans** pour leur plus grande satisfaction.



Produits en **conformité**  
avec les **directives CE.**

### NOUS CONTACTER

Par téléphone :  
de **09h00 à 12h00**  
de **14h00 à 17h30**  
du lundi au jeudi  
(**16h30** le vendredi)

Téléphone : **+ 33 (0)3 89 60 11 88**  
Fax : **+ 33 (0)3 89 59 32 77**

Par email :  
**nussbaum.medical@gmail.com**

Par courrier :  
**Société NUSSBAUM MEDICAL**  
31D, rue Victor Schœlcher  
BP 3106  
68062 MULHOUSE Cedex